

# User Manual

COMMONTALK INTERPHONE/PAGING SYSTEM TP-6RC/12RC



- Thank you for purchasing COMMAX products.
- Please carefully read this User's Guide (in particular, precautions for safety) before using a product and follow instructions to use a product exactly.
- The company is not responsible for any safety accidents caused by abnormal operation of the product.

## Safety Warning & Caution

Please follow the things described below in order to prevent any danger or property damage.

	<b>Warning</b>	It may cause a serious damage or injury if violated.		Prohibition.
	<b>Caution</b>	It may cause a minor damage or injury if violated.		No disassembly
				No touch
				Must follow strictly.
				Shows plugging out the power cord without an exception
				Shows the warning and caution for an electric shock.
				Shows the warning and caution for a fire.

### Warning

### Power & Installation

<p>Please don't use several products at the same time on one power socket.</p> <ul style="list-style-type: none"> <li>It may cause a fire due to an abnormal overheating.</li> </ul> <p>Prohibition Fire</p>	<p>Please don't bend the power cable excessively or it may cause an electric shock.</p> <ul style="list-style-type: none"> <li>fire when using a damaged power cable.</li> </ul> <p>Prohibition Electric shock Fire</p>	<p>Please don't handle the power cable with a wet hand.</p> <ul style="list-style-type: none"> <li>It may cause an electric shock.</li> </ul> <p>Prohibition Fire</p>	<p>Please plug out the power cable from the socket when not using it for a long period of time.</p> <ul style="list-style-type: none"> <li>It may shorten the product lifespan or cause a fire.</li> </ul> <p>Request Fire</p>
<p>Please don't install the product in the place where there is much oil, smoke or humidity.</p> <ul style="list-style-type: none"> <li>It may cause an electric shock or fire.</li> </ul> <p>Prohibition Electric shock Fire</p>	<p>Please don't install the product with the lightning and thunder.</p> <ul style="list-style-type: none"> <li>It may cause an electric shock or fire.</li> </ul> <p>Prohibition Electric shock Fire</p>	<p>Please don't use and connect this product with other products with different rated voltage.</p> <ul style="list-style-type: none"> <li>It may cause a disorder or fire.</li> </ul> <p>Prohibition Fire</p>	<p>When installing the product that generates heat, please install the product away from the wall (10cm) for the ventilation.</p> <ul style="list-style-type: none"> <li>It may cause a fire due to the increased internal temperature.</li> </ul> <p>Prohibition Fire</p>

## Warning

### Cleaning & Use

Please don't disassemble, repair or rebuild this product arbitrarily (please contact the service center if a repair is needed).

- It may cause an electric shock or fire.



If an abnormal sound, burning smell or smoke is coming out of the product, please plug out the power cable and contact a service center.

- It may cause an electric shock or fire.



Please don't insert any metallic or burnable materials into the ventilation hole.

- It may cause an electric shock or fire.

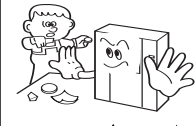

Please use only the designated batteries for the products of using DC power.

- It may cause an electric shock or fire.

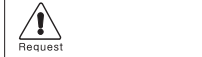
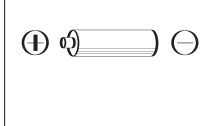

## Caution

### Power & Installation

Please plug the power cable firmly into the inner end.

- It may cause a fire.

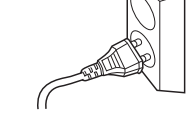

Please hold the plug tightly when unplugging the power cable (a part of the copper wire may be disconnected if the grabbing is only made on the cord when pulling out the cable).

- It may cause an electric shock or fire.

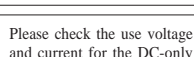
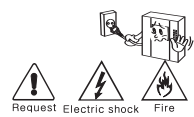

When connecting the power cables after cutting the cable, please install the product with power off.

- It may cause an electric shock or fire.

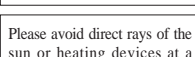
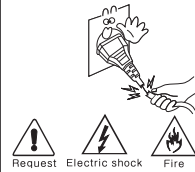

When installing the product, please fix it firmly while using the wall-mounting unit and screws.

- It may cause an injury from the falling object.

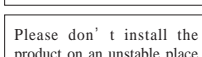
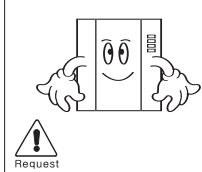

Please be careful when using an AC circuit breaker since there is a possibility of an electric shock.

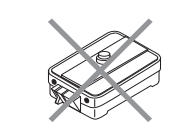

Please check the use voltage and current for the DC-only products and use the appropriate rectifier.

- It may cause a fire.

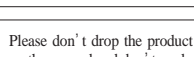
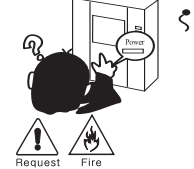

Please avoid direct rays of the sun or heating devices at a time of installation.

- It may cause a fire.

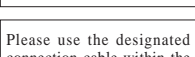

Please don't install the product on an unstable place or small support board.

- It may cause an injury if it falls down while in use.

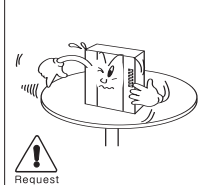

### Cleaning & Use

When cleaning the product, please rub it with a soft and dry cloth after plugging out the power cable. (Please don't use any chemical products such as wax, benzene, alcohol or cleanser.)



Please don't drop the product on the ground and don't apply a shock.

- It may cause a failure.

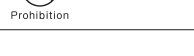
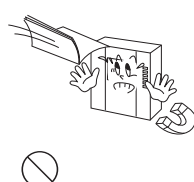

Please use the designated connection cable within the maximum calling distance designated for the product.

- It may reduce the product performance.

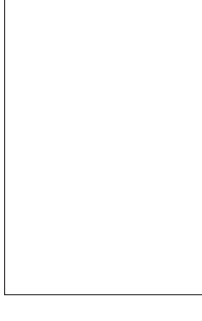

## ■ CONTROLS AND FUNCTIONS

### TP-nRC ROOMSTATION

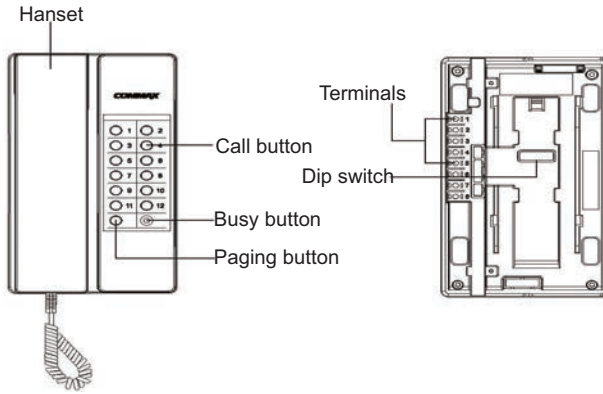

### DR-DW2N DOORSTATION

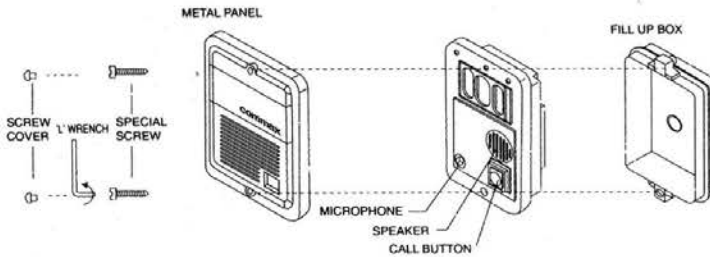

## ■ WIRING

This interphone is a simple wiring type and on all master and door entry system. According to customer's requirement, it can be composed of various system such as a 4 common wire in parallel system.

### External Paging Speaker (Optional)

A built-in amplifier in each interphone station permits the addition of an external speaker to any station located in an area where the ambient sound level may interfere with the ability to hear paging announcement and the call tone.

### Doorstation(Optional)

The commax Model DR-DW2N is a door station unit of TP-nRC interphone system and electric door releaser can be used with this doorphone system.

### Power Supply (Optional)

The commax Model RF-1A regulated power supply provides 12V $\overline{\text{~}}$ , 1A. A bracket is provided for mounting to a wall. A pilot lamp on the monitor illuminates when power has been applied.

BE SURE TO OBSERVE CORRECT POLARITY WIRING WHEN CONNECTING THE POWER SUPPLY TO THE JUNCTION TERMINAL.

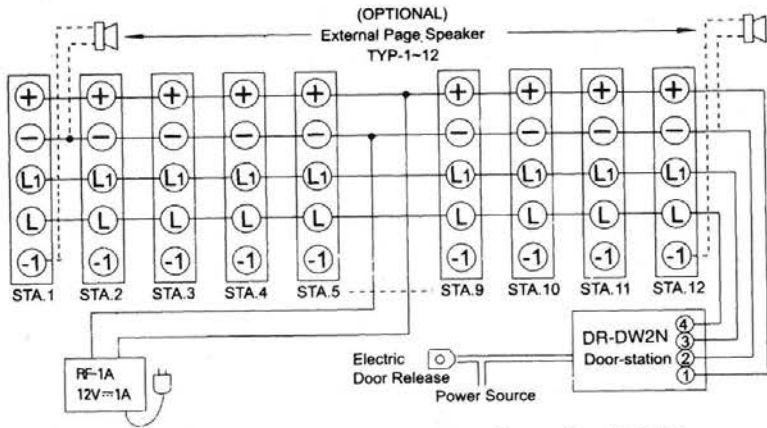

Figure-5 TP-nRC and DR-DW2N Connection Diagram

**NOTE**

J If the cable run is very long, connect the power supply to a junction terminal mid-way through the run.

J One power supply(RF-1 A) is recommended for each six station in a system.  
(Require two power supply(RF-1A) for more 7 stations of TP-nRC)

**■ FIXING A PIN OF STATION NUMBER**

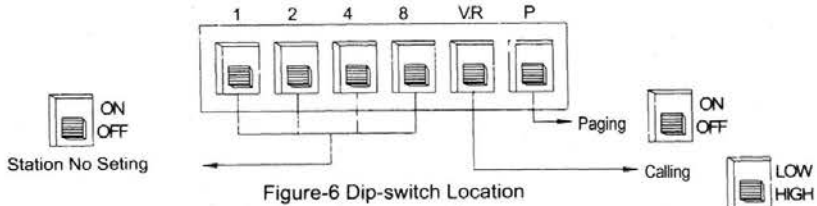
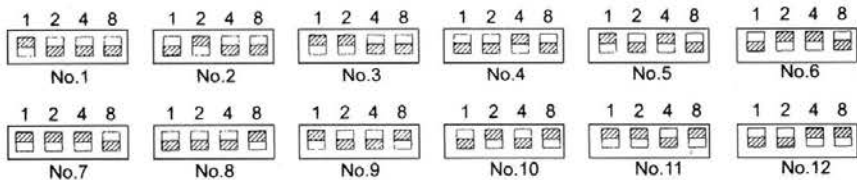

Figure-6 Dip-switch Location

The switch, its can be adjusted station number's on bottom side, has each interphone(TP-nRC) which switch consist of 6 positions. 2 position of right side is adjusted paging and calling volume TP-nRC 4 position of left side is adjusted stations number of each interphone(TP-nRC)

**EXAMPLE**



## ■ INSTALLATION

Each TP-nRC Interphone has a bracket to facilitate wall-mounted installation. Secure the bracket to the wall with screws provided. Fit the slots in the interphone base over the hooks on the bracket and pull the interphone down slightly to secure.

## ■ OPERATION INSTRUCTION

### CALLING ANOTHER STATION

1. Lift the handset and press the call button for the desired station.  
A tremolo call tone will sound at the station called.
2. You can hear a faint calling tone from your receiver.
3. To make a conference call, simultaneously press the desired call buttons.
4. When you have completed your call, replace the handset.

### \* RECEIVING A CALL

1. When the call tone sounds, lift the handset and reply.
2. Replace the handset when finished.

NOTE Calling sound can be adjusted by calling switch(Figure-6)

### \* ALL-CALL PAGING

1. Lift the handset and press and hold the paging button corresponding to the station you are using. speak into the handset

NOTE If not necessary the paging function. adjust the paging switch to "OFF" position (Figure-6)

### \* INTERPHONE DOORPHONE COMMUNICATION

1. Visitors press the call button on doorstation (DR-DW2N): then they listen to the chime sound with two tone from roomstation( TP-nRC)

NOTE: 1)Not calling sound at roomstation, if adjusted to "OFF" position in paging switch.

2)Pick up the handset within 12-15 seconds for talking.

3)When you are talking between interphones, you can hear faint calling sound from the doorstation through receiver.

2. Pick up the handset of roomstation and talk to the visitor.
3. Without pushing the call button, you can talk to the other party and can also maintain the conversation away from 30Cm.
4. After ascertainment of the visitor. the door opens by press the No 1 button on the roomstation.

## ■ SPECIFICATION

Power source	12V==
Current consumption	200mA
Effective distance	500M/0.65mm
wiring	4common wires



Memo

# **COMMAX**

## **COMMAX Co.,Ltd.**

513-11, Sangdaewon-dong, Jungwon-gu, Seongnam-si, Gyeonggi-do, Korea

Int'l Business Dept. Tel. : +82-31-7393-540~550 Fax. : +82-31-745-2133

Web site : [www.commax.com](http://www.commax.com)

*Printed In Korea / 2011.04.104*